

Overview

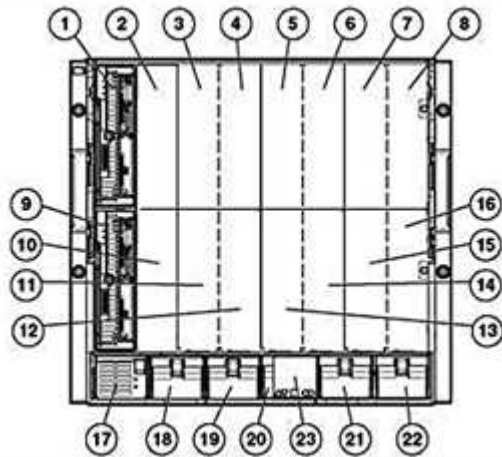

HP BladeSystem c7000 Enclosure - Front View

1. Device Bay 1
2. Device Bay 2
3. Device Bay 3
4. Device Bay 4
5. Device Bay 5
6. Device Bay 6
7. Device Bay 7
8. Device Bay 8
9. Device Bay 9
10. Device Bay 9
11. Device Bay 11
12. Device Bay 12
13. Device Bay 13
14. Device Bay 14
15. Device Bay 15
16. Device Bay 16
17. Power Supply Bay 1
18. Power Supply Bay 2
19. Power Supply Bay 3
20. Power Supply Bay 4
21. Power Supply Bay 5
22. Power Supply Bay 6
23. Insight Display

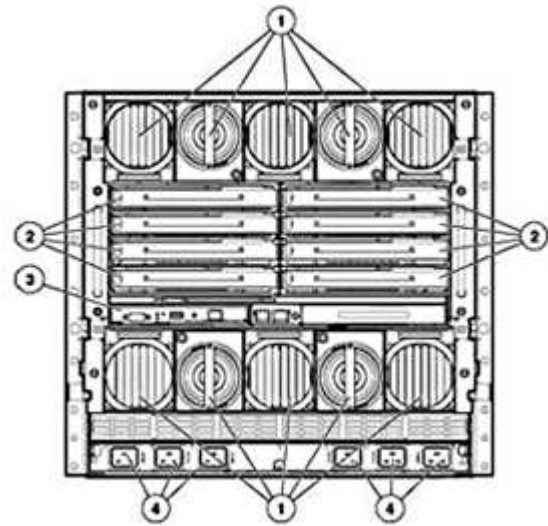

HP BladeSystem c7000 Enclosure - Rear View

1. Active Cool 200 Fans & fan bays
2. Interconnect Bays
3. BladeSystem Onboard Administrator
4. Power Inputs (single phase model shown)

What's New

- HP BLc Single Phase Intelligent Power Module

Overview

At A Glance

This document covers the HP BladeSystem c7000 Enclosure. For more information on HP ProLiant Server Blades and HP BladeSystem c-Class Interconnect Components please see the following QuickSpecs:

HP BladeSystem c-Class Server Blades:

<http://h18000.www1.hp.com/products/quickspecs/division/12534.html>

HP BladeSystem c3000 Enclosure QuickSpecs:

http://h18000.www1.hp.com/products/quickspecs/12790_div/12790_div.html

HP BladeSystem solutions start with a BladeSystem c7000 Enclosure, optional c7000 hot-plug power supplies, HP Active Cool Fans, and an optional redundant BladeSystem Onboard Administrator module. Once the enclosure has been selected, the following components can be added: networking interconnect modules, HP ProLiant and Integrity Server Blades, and Insight Control management software. Reference the QuickSpecs listed above.

- **Warranty** - This product is covered by a global limited warranty and supported by HP Services and a worldwide network of HP Authorized Channel Partners. Hardware diagnostic support and repair is available for three years from date of purchase. Support for software and initial setup is available for 90 days from date of purchase. Additional support may be covered under the warranty or available for an additional fee. Enhancements to warranty services are available through HP Care Pack services or customized service agreements.
 - Enclosure: Three-year parts and labor, on-site limited global warranty. Certain restrictions and exclusions apply
 - Enclosure options: Fans, Power Supplies, BladeSystem Onboard Administrator, 1 Year parts only or enclosure warranty
 - HP BladeSystem Interconnects: 1 Year parts and labor, on-site regardless of the warranty period for the system in which they are installed
 - HP Storage Fibre Channel switches have a maximum warranty period of one (1) year regardless of the warranty period for the system in which they are installed
 - Hard drives have either a one year or three year warranty; refer to specific hard drive QuickSpecs for details.

For additional information please visit: <http://www.hp.com/go/bladessystem>

HP BladeSystem c-Class Overview

HP BladeSystem c-Class c7000 Enclosure

A BladeSystem c7000 enclosure holds up to 16 server and/or storage blades plus redundant network and storage switches. It includes a shared, multi-terabit high-speed mid-plane for wire-once connectivity of server blades to network and shared storage. Power is delivered through a pooled power backplane that ensures the full capacity of the redundant hot-plug power supplies is available to all blades.

Each c7000 enclosure is built with the following functions:

- Up to 16 half-height and/or up to 8 full-height server blades and/or storage blades per enclosure.
- Up to 4 different interconnect fabrics (Ethernet, FC, IB, iSCSI, SAS, etc.) supported simultaneously within the enclosure.
- Choice of a single-phase, three-phase or a -48V DC power subsystem for flexibility in connecting to datacenter power.
- HP Thermal Logic technology for lower power consumption and airflow.
- Four (4) or Ten (10) Active Cool 200 fans as standard. For redundancy and improved power consumption and acoustics; additional Active Cool 200 Fan kits can be added for a maximum of 10 fans.
- Redundant hot-plug cooling, redundant hot-plug power supplies, redundant connections, redundant interconnect modules, optional redundant BladeSystem Onboard Administrator management modules.
- Lowest cost of ownership.
- Full AC redundancy - with no power zones.

An BladeSystem Onboard Administrator management module is built in to the enclosure with the following functions:

- Robust, multiple enclosure setup and control.
- Reports asset and inventory information for the devices in the enclosure.
- Reports thermal and power information, including real-time actual power usage per server and per enclosure.
- Front-mounted Insight Display for easy management within the datacenter.
- Integrated access to all server blade iLOs from a single cable.
- Provides integrated access to interconnect bay device management ports from the single BladeSystem Onboard Administrator cable.
- Single sign-on capability for all devices in the enclosure
- Role-based security locally and/or with LDAP directory services.
- Provides a wizard-based initial setup process for easy configuration.

A BladeSystem c7000 enclosure provides the following benefits:

- With local and remote hardware management integrated across the solution, one full enclosure can be managed as easily as one server.
- Scalable: Management and network interconnects extend scalability beyond a single enclosure, allowing resources to be pooled and shared across multiple enclosures.
- Investment protection: Accommodates multiple server and network designs in one enclosure.
- Lower costs per server, in comparison to rack-mounted servers
- Lower power consumption, in comparison to rack-mounted servers.
- Lower airflow requirements, in comparison to rack-mounted servers

HP c3000 Enclosure

For customers that need a smaller system the c3000 is the perfect solution. Supporting up to 8 blades and 4 interconnects the c3000 enclosure provides an ideal solution for Small and Medium businesses and remote sites for more information refer to the c3000 QuickSpecs at: http://h18000.www1.hp.com/products/quickspecs/12790_div/12790_div.html

HP BladeSystem c-Class Overview

HP ProLiant & Integrity Server Blades Delivering best-in-class performance, choice and reliability on AMD Opteron™, Intel® Xeon® and Intel® Itanium 2® processors for Windows, Linux, Solaris, or HP-UX based servers; the HP portfolio of server blades supports a variety of application requirements for scale-out architectures. HP offers one-, two-, and four-processor server blades, with the widest range of performance, and form factors.
For more information please see:
<http://h18000.www1.hp.com/products/quickspecs/division/12534.html>

HP SB40c Storage Blade

Direct attached storage

The SB40c Storage Blade delivers direct attached storage for c-Class servers, with support for up to six hot plug small form factor (SFF) SAS or SATA hard disk drives. The enclosure backplane provides a PCI Express connection to the adjacent c-Class server blade and enables high performance storage access without any additional cables. The SB40c Storage Blade features an onboard Smart Array P400 controller with 256 MB battery-backed write cache, for increased performance and data protection.

Shared storage

Use HP LeftHand P4000 Virtual SAN Appliance (VSA) software to turn the SB40c into an iSCSI SAN for use by all servers in the enclosure and any server on the network. HP LeftHand VSA software is installed in a virtual machine on a VMware ESX host server adjacent to the SB40c. HP LeftHand P4000 VSA turns the SB40c into a scalable and robust iSCSI SAN, featuring, storage clustering for scalability, Network RAID for storage failover, thin provisioning, snapshots, remote replication, and cloning. Expand capacity within the same enclosure or to other BladeSystem enclosures by adding additional SB40c Storage Blades and HP LeftHand VSA licenses. http://h18000.www1.hp.com/products/quickspecs/12587_div/12587_div.html

HP Ultrium Tape Blades

The HP SB1760c is an LTO-4 Ultrium, 1.6 TB capacity on a single cartridge (2:1 compression), 576 GB/hr performance (2:1 compression), 128 MB buffer size, WORM capability, AES 256-bit hardware data encryption capability.

Tape blades are ideal for HP BladeSystem c-Class customers who need a data protection solution but are not connected into a Storage Area Network (SAN). They provide direct attach data protection for the adjacent server and network backup protection for all other data within the enclosure. The HP tape blades are the industry's first bladed tape drives and are developed exclusively for the BladeSystem c-Class enclosures.

For more information, please visit:

http://h18000.www1.hp.com/products/quickspecs/12729_div/12729_div.html

HP Network Storage Servers

HP X1800sb Network Storage Blade

HP X1800sb Network Storage Blade is a flexible storage server solution for BladeSystem environments. Combine the X1800sb with the SB40c Storage Blade to enable file serving and iSCSI shared storage inside the BladeSystem enclosure. The flexibility of the X1800sb extends to external storage as well. The X1800sb can also be used as a low cost SAN gateway to provide consolidated file-serving access to FC, SAS, or iSCSI SANs.

NOTE: See the QuickSpecs for Technical Specifications and additional information:

http://h18000.www1.hp.com/products/quickspecs/12786_div/12786_div.html

HP X3800sb Network Storage Gateway

The X3800sb Network Storage Gateway Blade is used to access FC, SAS, or iSCSI SAN storage, translating file data from the server into blocks for storage to provide consolidated file, print, and management hosting services in a cluster-able package.

Built on the HP ProLiant BL460c Server Blade, the HP X3800sb Network Storage Gateway Blade is a ready to deploy SAN gateway solution, with Microsoft Storage Server 2008, Enterprise x64 Edition pre-installed. The HP Rapid Start-up Wizard accelerates new deployments by

HP BladeSystem c-Class Overview

walking you through basic system settings step-by-step. The X3800sb also includes a Microsoft Cluster Server (MSCS) license and Microsoft iSCSI Software Target.

NOTE: See the QuickSpecs for Technical Specifications and additional information:

http://h18006.www1.hp.com/products/quickspecs/13334_div/13334_div.html

Dynamic Power Capping

HP Dynamic Power Capping is the industry's first and only power capping solution that lets you reclaim trapped power and cooling capacity without putting electrical infrastructure or server performance at risk. The enclosure Dynamic Power Cap will be shared amongst all of the installed devices and individual server caps will be changed to match the server load. This will optimize the performance of the servers while ensuring that the enclosure stays below the cap value.

Rack Airflow Requirements

Rack 10000 G2 series cabinets

The increasing power of new high-performance processor technology requires increased cooling efficiency for rack-mounted servers. The G2 10000 Series Racks provide enhanced airflow for maximum cooling, allowing these racks to be fully loaded with servers using the latest processors.

NOTE: For operation with the DC Input Module the G2 1000 Series Rack Extension is required to allow DC Power Cabling to be installed.

CAUTION: If a third-party rack is used, observe the following additional requirements to ensure adequate airflow and to prevent damage to the equipment:

- Front and rear doors: If your 42U server rack includes closing front and rear doors, you must allow 830 square inches (5,350 sq cm) of hole evenly distributed from top to bottom to permit adequate airflow (equivalent to the required 64 percent open area for ventilation).
- The clearance from face of rack to inside of the front door needs to be 1.75" minimum.
- Side: The clearance between the installed rack component and the side panels of the rack must be a minimum of 2.75 inches (7 cm).
- Depth: Minimum 39.4 inches (1000mm) for AC power, 47 inches (1200mm) for DC Power Input
- Adjustable rack rails are shipped with each enclosure:
 - Minimum rail length: 25 inches (635mm)
 - Maximum rail length: 34 inches (864mm)

CAUTION: Always use blanking panels to fill all remaining empty front panel U-spaces in the rack. This arrangement ensures proper airflow. Using a rack without blanking panels results in improper cooling that can lead to thermal damage.

Factory Express Portfolio for Servers and Storage

HP Factory Express offers configuration, customization, integration and deployment services for HP servers and storage products. Customers can choose how their factory solutions are built, tested, integrated, shipped and deployed.

Factory Express offers service packages for simple configuration, racking, installation, complex configuration and design services as well as individual factory services, such as image loading, asset tagging and custom packaging. HP products supported through Factory Express include: a wide array of servers and storage: HP Integrity, HP ProLiant & HP ProLiant & Integrity Server Blades, HP BladeSystem, HP 9000 servers as well as the MSAxxxx, VA7xxx, EVA, XP, rackable tape libraries and configurable network switches.

For more information on Factory Express services for your specific server model please contact your sales representative or go to: <http://www.hp.com/go/factory-express>

HP BladeSystem c-Class Overview

HP Enterprise Configurator

The HP eConfigure Enterprise Configurator now provides factory default racking for our HP hardware portfolio. This approach is aligned with our strategic direction to meet the needs and expectations of our valued customers. If you require "custom" rack configuration, please contact HP's Customer Business Center or an Authorized Partner for assistance.
<http://www.hp.com/products/configurator>

HP Insight management software

Insight Management

Managing the growing number of servers can be complex and expensive for your organization. IT managers need to address changing business needs with tools that meet the challenges of managing today's complex Datacenters.

HP Insight Management lowers the cost of running your HP ProLiant servers by providing you with best-in-class management tools, including HP Insight Control, HP Virtual Connect Enterprise Manager (VCEM), and HP Insight Dynamics / Matrix Operating Environment. Insight Management increases your productivity and reduces your operating costs to get you higher value from your HP ProLiant servers.

Electronic download of Insight Management Media
Insight Management software media is available for free download (not including license entitlement certificates) at this website:
<http://www.hp.com/go/insightupdates>.

Software media available for download includes:

- HP Insight Control
- HP Insight Control for Microsoft® System Center
- HP Insight Control for VMware vCenter Server
- HP Virtual Connect Enterprise Manager (VCEM)
- HP Insight Dynamics / Matrix Operating Environment

Customers will receive an Insight Control or Insight Dynamics license entitlement certificate via physical shipment or email. The license entitlement certificate must be redeemed online or via fax in order to obtain the license activation key(s).

One year of 24x7 Software Technical Support and Updates are included with your purchased licenses.

HP provides a complete range of installation and support services to ensure the successful deployment and operations of your server infrastructure. For more information about support services and licensing

options, see the following website:
<http://www.hp.com/go/insightsoftware>

Insight Software Media Kit (DVDs)

Physical media (DVDs) are also available for purchase from HP or from your authorized reseller (PN 436222-B21)

HP Insight Foundation

Insight Foundation is being baselined at version v8.70 which means the following:

- Its Media Kit (contains 2 SmartStart CDs, the Firmware DVD, and the Management DVD) will continue to ship with all supported ProLiant G7 or earlier BTO servers until the last supported server is no longer shipping.
- The media kit was an orderable option for BladeSystem

HP BladeSystem c-Class Overview

enclosures, so changes mean:

- ProLiant G7 or earlier CTO servers are able to order the Media Kit with the understanding that the media is not updated.
- The Media Kit will not be updated past version 8.70.
- PSP and Firmware DVD downloads will be updated through the second release of the ProLiant Gen8 servers at the HP Insight Foundation Suite for ProLiant downloads tab:
<http://www.hp.com/go/foundation>

Customers are urged to use the replacement product, HP Service Pack for ProLiant, instead of Insight Foundation Suite which is found at these location:

- www.hp.com/go/spp
- www.hp.com/go/spp/download

HP Integrated Lights-Out (iLO)

HP Integrated Lights-Out (iLO) simplifies server setup, health monitoring, power and thermal control, and lights-out remote administration of ProLiant ML, DL, and BL servers. HP iLO functions without additional software and can be accessed from any location via a web browser. HP iLO works hand-in-hand with HP Systems Insight Manager, Insight Control and Insight Dynamics for ProLiant, helping customers unleash the value of the ProLiant platform and deliver the highest possible quality of IT service. For more information, visit: www.hp.com/go/iLO

HP Insight Control

HP Insight Control, a product option, delivers essential infrastructure management that can help save time and money by making it easy to deploy, monitor, remote control, and optimize your IT infrastructure through a single, simple management console.

Two versions of Insight Control are available, to serve environments requiring either a Linux-based or a Windows-based central management servers: HP Insight Control for Linux, and HP Insight Control. See www.hp.com/go/insightcontrol

HP Insight Control includes one year of 24 x 7 HP Software Technical Support and Update Service ensuring rapid access to HP support staff and proactive delivery of software updates. For more information about this service, please visit: <http://www.hp.com/services/insight>.

HP Matrix Operating Environment

The HP Matrix Operating Environment (Matrix OE) for ProLiant and Integrity servers is an integrated command center that helps you instantly adjust to dynamic business demands. This advanced infrastructure management software lets you reduce the cost of common data center tasks by up to 40 percent while keeping pace with your changing business.

The HP Matrix OE includes the automated provisioning, optimization, and recovery management capabilities for HP CloudSystem Matrix, the ideal platform for private cloud and Infrastructure as a Service (IaaS).

NOTE: For more information, visit: <http://www.hp.com/go/matrixoe>

HP BladeSystem c-Class Overview

HP BladeSystem Power Sizer

The HP BladeSystem Power Sizer helps in sizing the power infrastructure needed for a HP BladeSystem solution. This sizer enables effective planning for the power consumption and heat load of the BladeSystem at its site.

The sizer enables you to:

- Select the type and number of components within each Blade Server and Blade Enclosure.
- View the effect of component changes on the power consumption and heat loading.
- Review server loading and determine power supply and power subsystem requirements.
- Approximate electrical and heat load for facilities planning purposes.

The sizing estimate is based on component level power measurements for a system operating at very high enterprise application loads.

Values obtained from the BladeSystem Power Sizer are estimates for planning purposes only. Actual measured power consumption can be significantly lower or higher than the Power Sizer estimates. Actual power consumption varies with application type, application utilization, and ambient temperature.

The p-class BladeSystem and the c-Class BladeSystem solutions are supported in the BladeSystem Power Sizer.

Available at: www.hp.com/go/bladeSystem/powercalculator

HP Power Advisor

The HP Power Advisor is a tool provided by Hewlett-Packard to assist in the estimation of power consumption and proper selection of components including power supplies at a system, rack, and multi-rack level. A variety of additional features are also provided including a condensed bill of materials, a cost of ownership calculator, and a power report. The HP Power Advisor allows for the mixing of rack, tower, blade, and other products in a single environment.

Available at: www.hp.com/go/hppoweradvisor

Service and Support

Service and Support **HP Technology Services for Industry Standard Servers and BladeSystem**
Capitalizing on HP ProLiant server and HP BladeSystem capabilities requires a service partner who understands your increasingly complex business technology environment. That's why it makes sense to team up with the people who know HP infrastructure hardware and software best - the experienced professionals at HP Services.

What HP ProLiant and BladeSystem Services can do for you

HP ProLiant and BladeSystem Services can help you design, deploy, test, integrate, support, and manage IT and infrastructure solutions. This way, HP proposes services solutions that include more than just uplift of base warranty. Foundation Care services deliver scalable support-packages for HP industry-standard servers and software. You can choose the type and level of service that is most suitable for their business needs. New to this portfolio is HP Collaborative Support. If you are running business critical environments, HP offers Proactive Care or Critical Advantage. These services help deliver high levels of application availability through proactive service management and advanced technical response.

You can get the support you need by choosing from one of a number of service packaged solutions we have designed to address wider set of customer support needs.

HP Technology Services meets business challenges with services offered in three support recommendations - Optimized Care Package, Standard Care Package, and Basic Care - available for each product group. Such packaged solutions enable customers to optimize technology operations, minimize risk and drive better business outcomes with easy-to-buy, easy-to-use scalable support packages for servers, storage, networking and software. All three service recommendations include support services from the broader portfolio of Foundation Care and Proactive Care services.

Optimized Care Package

Supports maintaining servers at optimum performance availability

HP Installation and Startup Service for HP BladeSystem c-Class Infrastructure for c3000/c7000 enclosure

Provides for the installation and startup of a BladeSystem c3000 Infrastructure in a single blade enclosure including hardware and software, including deployment of OS, HP SIM, RDP, RDP, PMP and VPM. <http://h20195.www2.hp.com/V2/GetPDF.aspx/4AA0-5964ENW.pdf>

3-Year HP 24x7 4 hour Response, Proactive Care OR Critical Advantage for c3000/c7000 enclosure + 3-Year HP 24x7 4 hour Response, Proactive Care or Critical Advantage for Blade server

Helps optimize your systems and delivers high levels of application availability through proactive service management and advanced technical response. A skilled Technical Manager will own your query or issue end to end until resolved, delivering a single point of contact for you. <http://h20195.www2.hp.com/V2/GetPDF.aspx/4AA3-2140ENW.pdf>

Additional Services: Virtualization Services - Strategy, Design, Transition, Operation, Continual Service Improvement.

Standard Care Package **Support Recommendation that maintains high level of server availability**

HP Installation and Startup Service for HP BladeSystem c-Class Infrastructure for c3000/c7000 enclosure

Provides for the installation and startup of a BladeSystem c3000 Infrastructure in a single blade enclosure including hardware and software, including deployment of OS, HP SIM, RDP, RDP, PMP and VPM. <http://h20195.www2.hp.com/V2/GetPDF.aspx/4AA0-5964ENW.pdf>

HP Installation and Startup Service for HP BladeSystem c-Class Enhanced Network

HP Provides for the configuration and testing of BladeSystem Ethernet interconnect switches to facilitate proper implementation of network protocols and access to advanced features. <http://h20195.www2.hp.com/V2/GetPDF.aspx/4aa0-5969ENW.pdf>

Service and Support

3-Year, HP 24x7 4 hour Response, Collaborative Support for c3000/c7000 enclosure + 3-Year, HP 24x7 4 hour Response, Collaborative Support for Blade server
Offers customers a single point of contact for server problem diagnosis, hardware problem resolution, and basic software problem diagnosis, fault isolation, and resolution if available to HP. If the problem is with HP HW, the representative will arrive on site any time and day of the year to begin hardware maintenance service within 4 hours of the service request being logged. In case, the issue is with HP or supported third-party software product and cannot be resolved by applying known fixes, HP will contact the third-party vendor and create a problem incident on your behalf.

3-Year , HP 24x7 Software Support for Insight Control

Provides for the deployment and basic configuration of HP Insight Control on HP ProLiant ML and DL series servers or HP BladeSystem servers.

<http://h20195.www2.hp.com/V2/GetPDF.aspx/5981-6645EEE.pdf>

1-Year HP Proactive Select 30 Credit

Provides a flexible way to purchase HP best-in-class consultancy and technical services.

<http://h20195.www2.hp.com/v2/GetPDF.aspx/4AA2-3842ENN.pdf>

Additional Services: Software OS (Microsoft, Linux (SUSE/Red Hat) & VMware Installation & Start Up and Software Support); Microsoft or Linux or VMware education courses; +60 Proactive Select Credits, Factory Express.

Basic Care Package

Delivers minimum recommended support service level

HP Installation and Startup Service for HP BladeSystem c-Class Infrastructure for c3000/c7000 enclosure

Provides for the installation and startup of a BladeSystem c3000 Infrastructure in a single blade enclosure including hardware and software, including deployment of OS, HP SIM, RDP, RDP, PMP and VPM.

<http://h20195.www2.hp.com/V2/GetPDF.aspx/4AA0-5964ENW.pdf>

3-Year, HP 24x7 4 hour Response, Hardware Support Onsite Service for c3000/c7000 enclosure + 3-Year, HP 24x7 4 hour Response, Hardware Support Onsite Service for Blade server

Provides you with rapid remote support and if required an HP authorized representative who will arrive on site any time and day of the year to begin hardware maintenance service within 4 hours of the service request being logged.

<http://h20195.www2.hp.com/V2/GetPDF.aspx/5982-6547EEE.pdf>

3-Year , HP 24x7 Software Support for Insight Control

Provides for the deployment and basic configuration of HP Insight Control on HP ProLiant ML and DL series servers or HP BladeSystem servers.

<http://h20195.www2.hp.com/V2/GetPDF.aspx/5981-6645EEE.pdf>

1-Year HP Proactive Select 10 Credit

Provides a flexible way to purchase HP best-in-class consultancy and technical services.

<http://h20195.www2.hp.com/v2/GetPDF.aspx/4AA2-3842ENN.pdf>

Additional Services: Startup Blade System c-Class Enhanced Network Service; Software OS (Microsoft, Linux (SUSE/Red Hat) & VMware Installation & Start Up and Software Support); +30 Proactive Select Credits, Factory Express.

Insight Remote Support

Provides 24 X 7 remote monitoring, proactive notifications, and problem resolution. Learn more

<http://www.hp.com/go/insightremotesupport>

HP Support Center

Personalized online support portal with access to information, tools and experts to support HP business products. Submit support cases online, chat with HP experts, access support resources or collaborate with peers. Learn more <http://www.hp.com/go/hpsc>

HP's Support Center Mobile App* allows you to resolve issues yourself or quickly connect to an



Service and Support

agent for live support. Now, you can get access to personalized IT support anywhere, anytime. HP Insight Remote Support and HP Support Center are available at no additional cost with a HP warranty, HP Care Pack or HP contractual support agreement.

**HP' Support Center Mobile App is subject to local availability.*

Warranty / Service Coverage

For ProLiant servers and storage systems, the services cover HP-branded hardware options qualified for the server, purchased at the same time or afterward, internal to the enclosure, as well as external monitors up to 22" and tower UPS products; these items will be covered at the same service level and for the same coverage period as the server unless the maximum supported lifetime and/or the maximum usage limitation has been exceeded. Coverage of the UPS battery is not included; standard warranty terms and conditions apply.

The defective media retention service feature option applies only to Disk or eligible SSD/Flash Drives replaced by HP due to malfunction. It does not apply to any exchange of Disk or SSD/Flash Drives that have not failed. SSD/Flash Drives that are specified by HP as consumable parts and/or that have exceeded maximum supported lifetime and/or the maximum usage limit as set forth in the manufacturer's operating manual or the technical data sheet are not eligible for the defective media retention service feature option.

For more information

To learn more on HP ProLiant servers and HP BladeSystem servers, please contact your HP sales representative or HP Authorized Channel Partner. Or visit:

www.hp.com/services/bladeSystem

Configuration Information Factory Integrated Models

For a complete configuration of the HP BladeSystem, please do the following:

Step 1: Select desired model, configuration and quantity of HP ProLiant server and Storage blades

NOTE: For server blade information, please visit:

<http://h18000.www1.hp.com/products/quickspecs/division/12534.html>

NOTE: For Storage Blade information, please visit:

http://h18000.www1.hp.com/products/quickspecs/12587_div/12587_div.html

Step 2: Determine quantity of HP BladeSystem c-Class Enclosures to purchase and choose Required Options (One of the following from each list unless otherwise noted):

NOTE: Each HP BladeSystem c-Class Server Blade Enclosure holds up to 16 half-height blades. Server blanks will be shipped in all empty bays.

Base Server Blade Enclosure Configuration

HP BladeSystem BLc7000 c-Class Server Blade Enclosures	HP BLc7000 Configure-to-order 3 In LCD ROHS Enclosure	507019-B21
	HP BLc7000 Configure-to-order c-Class Enclosure	AD361C
	NOTE: CTO models include 1x BladeSystem Onboard Administrator with KVM, 4x Active Cool 200 Fans and 0x power supplies.	
	NOTE: All c-Class enclosures support HP ProLiant, Integrity and blades in either mixed or homogenous configurations. The AD361C enclosure is suggested for configurations primarily used with Integrity blades.	

Required Options (one of the following from each category unless otherwise noted)

HP Power Supplies	c-Class Power Modules (1 per enclosure)	
	HP BLc 1PH Intelligent Power Mod FIO Opt	677595-B21
	HP BLc7000 1 PH FIO Power Module Option	413379-B21
	HP BLc7000 3 PH Intl FIO Power Module Option	413381-B21
	HP BLc7000 3 PH NA/JP FIO Power Module Option	413380-B21
	HP BLc7000 -48V DC Power Input Module	AH331A
	c-Class Power Supply (Up to 6)	
	HP 6X 2400W Platinum Hot Plug Factory Integrated Power Supply Kit	517521-B22
	NOTE: The bundle includes a quantity of 6 HP 2400W Platinum 94% PSU so a full enclosure can be configured with a single part number.	
	NOTE: HP BladeSystem Power supplies meet multiple Energy Efficiency Initiatives: 2400W, 94%: Climate Savers Computing Initiative PLATINUM and ECOS Consulting 80 Plus PLATINUM.	
	HP 2400W Platinum Hot Plug Power Supply Kit	588603-B21
	NOTE: HP BladeSystem Power supplies meet multiple Energy Efficiency Initiatives: 2400W, 94%: Climate Savers Computing Initiative PLATINUM and ECOS Consulting 80 Plus PLATINUM.	
	HP 6X 2400W Gold Hot Plug Factory Integrated Power Supply Kit	517521-B21
	NOTE: The bundle includes a quantity of 6 HP 2400W High Efficiency PSU so a full enclosure can be configured with a single part number.	
	HP 2400W Gold Hot Plug Power Supply Kit	499243-B21
	HP 2250W -48VDC Hot Plug Power Supply Kit	AH332A
	NOTE: Only compatible with -48V DC Power Input Module.	

Configuration Information Factory Integrated Models

NOTE: Mixing of power supplies in the same enclosure is Not SUPPORTED. All power supplies must be of the same type. All HP 2400W HE, all HP2250W or all -48V DC.

NOTE: If Three Phase Power Module selected, a minimum of 3 Power Supply Option Kits are needed. For full redundancy 6 Power Supply Option Kits are required.

HP Cooling Options	c-Class Active Cool Fan (Up to 6)	
	6x HP Active Cool 200 Fan Bundle, FIO	517520-B21
	NOTE: The bundle includes a quantity of 6 HP Active Cool 200 Fans so a full enclosure can be configured with a single part number.	
	HP BLc7000 Enclosure HP Single Active Cool Fan Option Kit	412140-B21
	NOTE: A minimum of 4 Active Cool 200 Fans is required, 8 Active Cool 200 Fans can support a full blade enclosure, 10 Active Cool 200 Fans should be ordered for reduced power consumption and noise reduction.	
	NOTE: Single-Phase models may require additional power supplies. Fans should be added to provide redundancy, reduce power consumption and reduce noise.	
	NOTE: Three-Phase models require a minimum of 6 Active Cool 200 Fans.	
	NOTE: Some Blade configurations require 10 fans.	

Step 3: Select optional software bundle (if nothing is selected system will ship with 16 Insight Control and Insight Control for Linux Trial Licenses):

HP Insight Software	Enclosure Options	
	HP Insight Control for BladeSystem including 1yr 24x7 Support Enclosure 16 Server FIO License	417688-B23
	HP Insight Control for BladeSystem including 1yr 24x7 Support Enclosure 8 Server FIO License	439034-B23

Step 4: Select optional Redundant BladeSystem Onboard Administrator Capability

HP c-Class Enclosure Options	HP BLc7000 Onboard Administrator with KVM Option	456204-B21
	NOTE: With 1 Gb/s Adapters.	
	NOTE: The HP c7000 OA supports the mixing with the HP c7000 OA with KVM. The HP c7000 OA with KVM must be the active OA to provide the Enclosure KVM feature. The KVM menu has an OA CLI button at the bottom, which allows an OA administrator to log into the OA and be able to force a takeover so the OA with KVM will become the standby OA. The OA Firmware Sync feature cannot be used to update mismatched OA modules. Mismatched OA firmware versions between the original c7000 OA and c7000 OA with KVM require the administrator to use the GUI or CLI to update the OA from a file (http, ftp, tftp, local client file using the GUI or USB key containing the OA firmware file).	
	NOTE: Models of the c7000 enclosure (part numbers 507019-B21 and AD361C) come with a BladeSystem Onboard Administrator with KVM as standard. Order this part number (456204-B21) when a second redundant BladeSystem Onboard Administrator is desired for a c7000 enclosure.	

Configuration Information Factory Integrated Models

Step 5: Select 1 or more interconnect modules for each enclosure

The following is a list of various HP BladeSystem c-Class interconnect modules (Virtual Connect, Ethernet, Fibre Channel, InfiniBand, and SAS interconnects). For detailed interconnect options consult the specific interconnect QuickSpecs:

<http://h18004.www1.hp.com/products/blades/components/c-class-interconnects.html>

A pair of interconnects must be ordered if redundancy is required.

NOTE: Options for specific c-Class interconnects are NOT included in the list below. Consult the individual interconnect QuickSpecs to obtain part numbers for interconnect options such as cables, SFPs, etc.

HP BladeSystem c-Class Network Interconnects	HP Virtual Connect Flex-10 10Gb Ethernet Module for c-Class BladeSystem	455880-B21
	HP Virtual Connect Flex-10 Ethernet Module with Enterprise Manager License NOTE: Includes two HP Virtual Connect Flex-10 10Gb Ethernet modules plus one BL-c7000 enclosure license for HP Virtual Connect Enterprise Manager software. The license entitlement certificate must be redeemed online or via fax to obtain the VCEM license activation key.	591973-B21
	HP Virtual Connect FlexFabric 10/24 Enterprise Edition BLc7000 Option NOTE: Includes 2 x HP Virtual Connect FlexFabric 10Gb/24-port modules plus 1 x VCEM BL-c7000 enclosure license. Customer will receive a printed license entitlement certificate and 2 Virtual Connect modules as a single deliverable. The license entitlement certificate must be redeemed online or via fax to obtain the VCEM license activation key.	605865-B21
	HP Virtual Connect FlexFabric 10Gb/24-port Module for c-Class BladeSystem	571956-B21
	HP 1/10Gb-F Virtual Connect Ethernet Module for c-Class BladeSystem	447047-B21
	HP 6120G/XG Ethernet Blade Switch	498358-B21
	HP 6120XG Blade Switch	516733-B21
	HP 1GB Ethernet Pass-Thru Module for c-Class BladeSystem	406740-B21
	HP 10GbE Ethernet Pass-Thru Module for c-Class BladeSystem	538113-B21
	Cisco Catalyst 1/10GbE 3120X Blade Switch	451439-B21
	Cisco Catalyst 1GbE 3120G Blade Switch	451438-B21
	Cisco Catalyst Blade Switch 3020 for HP c-Class BladeSystem	410916-B21
	HP GbE2c Layer 2/3 Ethernet Blade Switch	438030-B21
	HP 1:10Gb Ethernet Blade Switch for c-Class BladeSystem NOTE: The HP BladeSystem c-Class Network Interconnects ship as single units. The above interconnects must be ordered in quantities of two for redundancy support.	438031-B21
	HP BladeSystem c-Class SAN Interconnects	HP Virtual Connect 8Gb 24-port Fibre Channel Module for c-Class BladeSystem
HP Virtual Connect 8Gb 20-port Fibre Channel Module for c-Class BladeSystem		572018-B21
HP 4GB Fibre Channel Pass-thru Module for c-Class BladeSystem		403626-B21
HP B-series 8/12c SAN Switch for BladeSystem c-Class		AJ820A
HP B-series 8/24c SAN Switch for BladeSystem c-Class		AJ821A
HP B-series 8/24c Power Pack+ SAN Switch for BladeSystem c-Class		AJ822A
HP B-series 8/12c SAN Switch for BladeSystem c-Class 12-port Upgrade LTU		T5517A
Cisco MDS 9124e Fabric Switch for HP c-Class BladeSystem	Cisco MDS 9124e Switch for c-Class BladeSystem 12-port Upgrade LTU	T5169A
	HP SAS Switch	HP 3Gb 8-port SAS 2.0 BL-c Switch Module for BladeSystem c-Class Enclosure
HP BladeSystem InfiniBand	HP 4X QDR QLogic InfiniBand Switch Module for c-Class BladeSystem	505958-B21
	QLogic InfiniBand 4X QDR Management Module for c-Class BladeSystem	505959-B21

Configuration Information Factory Integrated Models

Interconnects	HP 4X QDR InfiniBand Switch Module for c-Class BladeSystem NOTE: Quad Data Rate (QDR) InfiniBand Switch Modules are only supported in the RoHS 6 of 6 compliant enclosures (part numbers starting with 507) and G6 Blades.	489184-B21
	HP BLc 4X FDR IB Managed Switch	648311-B21
	HP BLc 4X FDR IB Switch	648312-B21

Step 6: Select rack power distribution for single-phase models

NOTE: A pair of PDUs must be ordered for AC Feed redundancy.

HP Power Distribution Units	HP Monitored Power Distribution Unit: Half Rack Version	
	HP 17.3kVA 48A Single Input Three Phase NA/JP Monitored Power Distribution Unit	AF916A
	HP 7.3kVA 32A Single Input Three Phase INTL Intelligent Modular Power Distribution Unit	AF536A
	HP 22kVA 32A Single Input Three Phase INTL Monitored Power Distribution Unit	AF917A
	NOTE: Please see the QuickSpecs for Technical Specifications and additional information: http://h18000.www1.hp.com/products/quickspecs/12118_div/12118_div.html (Worldwide)	
	HP Modular Power Distribution Units	
	HP 17.3kVA 48A Three Phase NA/JP Modular Power Distribution Unit	AF511A
	HP 22kVA 32A Three Phase INTL Core Modular Power Distribution Unit	AF518A
	HP 8.6kVA 24A Three Phase NA/JP Modular Power Distribution Unit	AF512A
	HP 11kVA 16A Three Phase INTL Modular Power Distribution Unit	AF513A
	HP 8.3kVA 40A High Voltage NA/JP Core Modular Power Distribution Unit	252663-D75
	HP 9.2kVA 40A High Voltage INTL Core Modular Power Distribution Unit	252663-B34
	HP 7.3kVA 32A High Voltage INTL Core Modular Power Distribution Unit	252663-B33
	HP 4.9kVA 24A High Voltage NA/JP Core Modular Power Distribution Unit	252663-D74
	NOTE: Please see the QuickSpecs for Technical Specifications and additional information: http://h18000.www1.hp.com/products/quickspecs/11041_div/11041_div.html (Worldwide)	
	NOTE: The Core Only Modular Power Distribution Unit Kits excludes the extension bars as they are not required with the HP BladeSystem	
	HP Two C13 PDU Extension Bar	AF500A
	NOTE: Each extension bar has a C19 input and 7 C13 receptacles. The option is ideal for model S348, and, model S332, which both have only C19 outlets (12) and for all Core Only Modular PDUs.	

Step 7: Select optional Power Cords for Single Phase Model (country specific power cords are listed under options)

NOTE: Default power cord is a 6ft IEC C19 - C20 cord

Configuration Information Factory Integrated Models

HP Intelligent Power Distribution Units	HP C19-C20 6.5ft SGL Data Special	TK738
Power cords (HP C19 to C20)	HP C19-C20 6.5ft 3PC Data Special	TK739
NOTE: Order with P/N 677595-B21	HP C19-C20 8.0ft SGL Data Special	TK740
	HP C19-C20 8.0ft 3PC Data Special	TK741
	HP C19-C20 10.0ft SGL Data Special	TK742
	HP C19-C20 10.0ft 3PC Data Special	TK743
	HP C19-C20 4.5ft SGL Data Special	TK744
	HP C19-C20 4.5ft 3PC Data Special	TK745
HP Power Distribution Units	HP 1.2m 16A C19-C20 Redundant Jumper Cord	AF575A
Power cords (HP C19 to C20)	HP 2m 16A C19-C20 Redundant Jumper Cord	AF574A
	HP 1xC19-C120 16A 2.5m Cable	295633-B22
	HP 4.5M Power Cord with C19/C20 Plug	E7804A

Related Options

HP BladeSystem c-Class Server Blade Enclosures	HP BLc7000 Enclosure with 1 Phase 6 Power Supply 10 Fan ROHS Full IC License	507015-B21
	HP BLc7000 Enclosure with 3 Phase 6 Power Supply 10 Fan ROHS Full IC License	507017-B21
	HP BLc7000 Enclosure with 3 Phase 6 Power Supply 10 Fan ROHS Full IC License	507016-B21
	HP BLc7000 Enclosure with 1 Phase 2 Power Supply 4 Fan ROHS Trial IC License	507014-B21
<p>NOTE: All c7000 BTO enclosures will ship with 15 server blanks. CTO enclosures will ship with the required number of server blanks.</p> <p>NOTE: New models of the c7000 enclosure (part numbers 5070xx-B21) come as standard with the HP 2400W HE PSU and BladeSystem Onboard Administrator with KVM.</p>		
HP Enclosure Options	HP BLc7000 Onboard Administrator with KVM Option	456204-B21
	<p>NOTE: The HP c7000 OA supports the mixing with the HP c7000 OA with KVM. The HP c7000 OA with KVM must be the active OA to provide the Enclosure KVM feature. The KVM menu has an OA CLI button at the bottom, which allows an OA administrator to log into the OA and be able to force a takeover so the OA with KVM will become the standby OA. The OA Firmware Sync feature cannot be used to update mismatched OA modules. Mismatched OA firmware versions between the original c7000 OA and c7000 OA with KVM require the administrator to use the GUI or CLI to update the OA from a file (http, ftp, tftp, local client file using the GUI or USB key containing the OA firmware file).</p> <p>NOTE: Models of the c7000 enclosure (P/Ns 507019-B21: 507015-B21, 507017-B21, 507016-B21, 507014-B21) come with a BladeSystem Onboard Administrator with KVM as standard. Order (P/N 456204-B21) when a second redundant BladeSystem Onboard Administrator is desired for a c7000 enclosure.</p>	
	HP BLc7000 10000 Series Rack Shipping Bracket Option	433718-B21
	<p>NOTE: The shipping bracket is required when shipping a c7000 enclosure when installed in a rack. It is not required for normal operation.</p>	
	HP BLc7000 Miscellaneous Blanks Option Kit	412148-B21
HP Power Supplies	HP BLc7000 Server Blank w/Coupler Option	412150-B21
	<p>NOTE: The coupler allows half-height server blanks to be coupled together to create a full-height server blank.</p> <p>NOTE: This kit should only be ordered to replace lost or damaged blanks.</p>	
	HP 2400W Platinum Hot Plug Power Supply Kit	588603-B21
	<p>NOTE: HP BladeSystem Power supplies meet multiple Energy Efficiency Initiatives: 2400W, 94%: Climate Savers Computing Initiative PLATINUM and ECOS Consulting 80 Plus PLATINUM.</p>	
	HP 2400W Gold Hot Plug Power Supply Kit	499243-B21
<p>NOTE: Supplied with 2m/6ft IEC C20 - C19 jumper cord.</p> <p>NOTE: HP BladeSystem Power supplies meet multiple Energy Efficiency Initiatives: 2400W, 92%: Climate Savers Computing Initiative GOLD and ECOS Consulting 80 Plus GOLD.</p>		
HP 2250W -48VDC Hot Plug Power Supply Kit	AH332A	
HP BLc7000 -48V DC Power Input Module	AH331A	
<p>NOTE: Mixing of power supplies in the same enclosure is not supported. All power supplies must be of the same type, all HP 2400W HE, all HP2250W or all -48V DC.</p> <p>NOTE: The 80 PLUS program is a unique forum that unites electric utilities, the computer industry, and consumers in an effort to bring energy efficient</p>		

Related Options

technology solutions to the marketplace. 80 Plus independently tests power supply efficiency and publically posts the results on 80Plus.org."

HP Cooling Options

HP c-Class Active Cool Fan

HP BLc7000 Enclosure HP Single Active Cool Fan Option Kit

412140-B21

NOTE: A minimum 4 Active Cool 200 Fans is required, 8 Active Cool 200 Fans can support a full blade enclosure, 10 Active Cool 200 Fans should be ordered for reduced power consumption and noise reduction. Some Blade configurations require 10 fans.

HP BladeSystem c-Class Network Interconnects

HP Virtual Connect Flex-10 10Gb Ethernet Module for c-Class BladeSystem

455880-B21

HP Virtual Connect Flex-10 Ethernet Module with Enterprise Manager License

591973-B21

NOTE: Includes 2 x HP Virtual Connect Flex-10 10Gb Ethernet modules plus 1 x VCEM BL-c7000 enclosure license. Customer will receive a printed license entitlement certificate and 2 Virtual Connect modules as a single deliverable. The license entitlement certificate must be redeemed online or via fax to obtain the VCEM license activation key

NOTE: For additional license kits, please visit:

http://h18000.www1.hp.com/products/quickspecs/12860_div/12860_div.html (Worldwide)

HP Virtual Connect FlexFabric 10/24 Enterprise Edition BLc7000 Option

605865-B21

NOTE: Includes 2 x HP Virtual Connect FlexFabric 10Gb/24-port modules plus 1 x VCEM BL-c7000 enclosure license. Customer will receive a printed license entitlement certificate and 2 Virtual Connect modules as a single deliverable. The license entitlement certificate must be redeemed online or via fax to obtain the VCEM license activation key.

HP Virtual Connect FlexFabric 10Gb/24-port Module for c-Class BladeSystem

571956-B21

HP 1/10Gb-F Virtual Connect Ethernet Module for c-Class BladeSystem

447047-B21

HP 6120G/XG Ethernet Blade Switch

498358-B21

HP 6120XG Blade Switch

516733-B21

HP 1GB Ethernet Pass-Thru Module for c-Class BladeSystem

406740-B21

HP 10GbE Ethernet Pass-Thru Module for c-Class BladeSystem

538113-B21

Cisco Catalyst 1/10GbE 3120X Blade Switch

451439-B21

Cisco Catalyst 1GbE 3120G Blade Switch

451438-B21

Cisco Catalyst Blade Switch 3020 for HP c-Class BladeSystem

410916-B21

HP GbE2c Layer 2/3 Ethernet Blade Switch

438030-B21

HP 1:10Gb Ethernet Blade Switch for c-Class BladeSystem

438031-B21

NOTE: The HP BladeSystem c-Class Network Interconnects ship as single units. The above interconnects must be ordered in quantities of two for redundancy support.

HP BladeSystem c-Class SAN Interconnects

HP Virtual Connect 8Gb 24-port Fibre Channel Module for c-Class BladeSystem

466482-B21

HP Virtual Connect 8Gb 20-port Fibre Channel Module for c-Class BladeSystem

572018-B21

HP 4GB Fibre Channel Pass-thru Module for c-Class BladeSystem

403626-B21

HP B-series 8/12c SAN Switch for BladeSystem c-Class

AJ820A

HP B-series 8/24c SAN Switch for BladeSystem c-Class

AJ821A

HP B-series 8/24c Power Pack+ SAN Switch for BladeSystem c-Class

AJ822A

HP SAS Switch

HP 3Gb 8-port SAS 2.0 BL-c Switch Module for BladeSystem c-Class Enclosure

AJ864A

HP 3Gb 8-port SAS 2.0 BL-c Switch Dual Pack Module for BladeSystem c-Class Encl

AJ865A

HP 6Gb SAS BL Switch Single Pack

BK763A

HP 6Gb SAS BL Switch Dual Pack

BK764A

Related Options

NOTE: Please see the QuickSpecs for Technical Specifications and additional information at:

http://h18000.www1.hp.com/products/quickspecs/13960_div/13960_div.html
(Worldwide)

HP BladeSystem InfiniBand Interconnects	HP 4X QDR QLogic InfiniBand Switch Module for c-Class BladeSystem	505958-B21
	QLogic InfiniBand 4X QDR Management Module for c-Class BladeSystem	505959-B21
	HP 4X QDR InfiniBand Switch Module for c-Class BladeSystem	489184-B21
	NOTE: Quad Data Rate (QDR) InfiniBand Switch Modules are only supported in the RoHS 6 of 6 compliant enclosures and G6 Blades.	
	HP BLc 4X FDR IB Managed Switch	648311-B21
HP Optical Drives	HP BLc 4X FDR IB Switch	648312-B21
	HP Integrity USB External DVD-RW Drive	AT120A

HP Insight Software

Insight Control

HP Insight Control for BladeSystem including 1yr 24x7 Support Enclosure 8 Server Electronic License

TC276AAE

HP Insight Control for BladeSystem including 1yr 24x7 Support Enclosure 16 Server Electronic License

TC277AAE

HP Insight Management Media Kit

436222-B21

NOTE: HP Insight Management Media Kit contains DVDs without licenses. Contains HP Systems Insight Manager, HP Insight Control, HP Matrix Operating Environment, and Virtual Connect Enterprise Manager software. Uses an integrated installer to perform quick and accurate software installation and updates.

NOTE: Licenses ship without media. The Insight Management Media Kit can be ordered separately, or can be downloaded at:

<http://www.hp.com/go/insightupdates>.

NOTE: The "for bundling with an enclosure" license kits can only be ordered together with a BladeSystem c3000 or c7000 enclosure on the same order.

NOTE: Customer will receive a license entitlement certificate, which must be redeemed online or via fax in order to obtain the license activation key(s). Includes one year of 24 x 7 HP Software Technical Support Service.

NOTE: For additional license kits, please see the QuickSpecs at:

http://h18000.www1.hp.com/products/quickspecs/12631_div/12631_div.html
(Worldwide)

HP Insight Control for Linux

HP Insight Control for Linux including 1yr 24x7 Support Enclosure 8 Server FIO License

TC211A

HP Insight Control for Linux w/1yr 24x7 Supp Enclosure Bundle Electronic 8 Svr LTU

TC211AAE

HP Insight Control for Linux including 1yr 24x7 Support Enclosure 16 Server FIO License

TC212A

HP Insight Control for Linux w/1yr 24x7 Supp Enclosure Bundle Electronic 16 Svr LTU

TC212AAE

NOTE: Licenses ship without media. The Media pack for Insight Control for Linux can be ordered separately, or can be downloaded at:

<http://www.hp.com/go/ic-linux> (click on Download button).

NOTE: Customer will receive a license entitlement certificate, which must be redeemed online or via fax in order to obtain the license activation key(s). Includes one year of 24 x 7 HP Software Technical Support Service.

NOTE: For additional license kits, please see the QuickSpecs at:

http://h18000.www1.hp.com/products/quickspecs/13019_div/13019_div.html
(Worldwide)

Related Options

HP Virtual Connect Enterprise Manager	<p>HP Virtual Connect Enterprise Manager including 1yr 24x7 Support Single c7000 Enclosure Lic</p> <p>NOTE: This license allows 1 BL-c7000 enclosure to be managed with VCEM. Customer will receive a printed license entitlement certificate via physical shipment. The license entitlement certificate must be redeemed online or via fax to obtain the license activation key(s). Includes one year of 24 x 7 HP Software Technical Support and Update Service.</p> <p>NOTE: For additional license kits, please visit: http://h18000.www1.hp.com/products/quickspecs/12860_div/12860_div.html (Worldwide)</p>	459864-B21
HP c-Class Storage Blades	<p>HP SB40c Storage Blade</p> <p>HP BL c-Class SB40c PCI Express Mezzanine Pass Thru Option Kit</p> <p>NOTE: The mezzanine card is needed to support the SB40c storage blade (P/N 411243-B21) with HP c-Class BladeSystem full-height server blades.</p> <p>HP SB40c with Virtual SAN Appliance Software Bundle</p> <p>HP SB40c Storage Blade with (4) 300GB Drive Bundle</p> <p>NOTE: Includes the SB40c Storage Blade and a single LeftHand P4000 VSA license. LeftHand VSA software is installed in a virtual machine on a VMware ESX host server adjacent to the SB40c.</p> <p>NOTE: Includes 1 yr 9x5 software support for LeftHand P4000 VSA software.</p> <p>NOTE: LeftHand P4000 VSA is supported on VMware ESX 3.0.2, 3.5 and ESX i version 3.5</p> <p>For detailed deployment information, see the HP LeftHand P4000 VSA in an HP BladeSystem environment solution guide: http://bizsupport1.austin.hp.com/bc/docs/support/SupportManual/c01729139/c01729139.pdf</p> <p>NOTE: For additional license kits, please visit: http://h18000.www1.hp.com/products/quickspecs/12587_div/12587_div.html (Worldwide)</p>	<p>411243-B21</p> <p>431643-B21</p> <p>AT459A</p> <p>AP762A</p>
HP Expansion Blades	<p>HP BLc PCI Expansion Blade</p> <p>NOTE: Please see the QuickSpecs for Technical Specifications and additional information: http://h18000.www1.hp.com/products/quickspecs/12753_div/12753_div.html (Worldwide)</p> <p>HP BL c-Class SB40c PCI Express Mezzanine Pass Thru Option Kit</p> <p>NOTE: The mezzanine card is needed to support the PCI Expansion Blade (P/N 448018-B21) with HP c-Class BladeSystem full-height server blades.</p>	<p>448018-B21</p> <p>431643-B21</p>

Related Options

HP Ultrium Tape Blades

HP LTO-4 SB1760c Tape Blade	AQ697A
HP BL c-Class SB40c PCI Express Mezzanine Pass Thru Option Kit	431643-B21
<p>NOTE: The HP PCI Express Mezzanine Pass-Thru Card for HP BladeSystem (431643-B21) is required when installing a tape blade adjacent to a full-height server blade</p> <p>NOTE: Please see the QuickSpecs for Technical Specifications and additional information: http://h18000.www1.hp.com/products/quickspecs/12729_div/12729_div.html (Worldwide)</p>	

HP Power Cords

HP LV Power Cords100 - 120V AC

Compaq 15A 125V Nema 5-15P/IEC320-C19 Power Cord	235603-001
HP 3.6m C19-NEMA 515P Japan Power Cord	391222-291
HP 4.5M Power Cord with 5-20P Plug	E7802A

HP C19 - C20 Jumper Cords

HP 1.2m 16A C19-C20 Redundant Jumper Cord	AF575A
HP 2m 16A C19-C20 Redundant Jumper Cord	AF574A
HP 1xC19-C120 16A 2.5m Cable	295633-B22
HP 4.5M Power Cord with C19/C20 Plug	E7804A

HP HV Power Cords 200 - 240V AC

HP 4.5M Power Cord with Nema L6-30P Plug	E7805A
HP 3.6m C19 NEMA L6-20P NA/JP Power Cord	AF593A
HP 3.6m 16A C19 NBR14136 Brazil Power Cord	AF592A
HP AC Line 16Amp C19 Power Cord	359615-031
HP 3.6m 16A C19 Power Cord	AF576A
HP 3.6m 16A C19 Power Cord	AF577A
HP 3.6m 16A C19 Power Cord	AF579A
HP 3.6m 16A C19 Power Cord	AF580A
HP 3.6m 16A C19 Power Cord	AF581A
HP 2.5m 16A C19 Power Cord	AF582A
HP 2.5m 16A C19 Power Cord	AF583A
HP 2.5m 16A C19 Power Cord	AF584A
HP 2.5m 16A C19 Power Cord	AF585A
HP 240 VAC 4.5M Unterminated End NA Power Cord	E7806A

NOTE: For additional power cable information, please visit:
<http://h18000.www1.hp.com/products/servers/proliantstorage/power-protection/options/power-cable.html>

Related Options

HP Uninterruptible Power Systems

HP Rack-mountable UPS

R5000 Uninterruptible Power System (UPS)

HP R5KVA 3U IEC309-32A High Voltage INTL Uninterruptible Power System AF461A

HP R5KVA 3U L630 High Voltage NA/JP Uninterruptible Power System AF460A

NOTE: Please see the QuickSpecs for additional information:

http://h18004.www1.hp.com/products/quickspecs/14109_div/14109_div.html
(Worldwide)

HP Rack-Mountable R5500 UPS

HP R5500 6000VA INTL 3U Rackmount Uninterruptible Power System AF416A

NOTE: Please see the QuickSpecs for additional information:

http://h18000.www1.hp.com/products/quickspecs/11871_div/11871_div.html
(Worldwide)

R7000 Uninterruptible Power System (UPS)

HP R7KVA 4U 50A High Voltage NA/JP Uninterruptible Power System AF462A

HP R7KVA 4U IEC-32A High Voltage INTL Uninterruptible Power System AF463A

NOTE: Please see the QuickSpecs for additional information:

http://h18004.www1.hp.com/products/quickspecs/14110_div/14110_div.html
(Worldwide)

HP Rack-mountable R8000/R12000 UPS

HP R8000/3 8000kVA Three Phase NA 6U Rackmount Uninterruptible Power System AF431A

HP R8000/3 8000kVA Three Phase INTL 6U Rackmount Uninterruptible Power System AF432A

HP R12000/3 12000VA Three Phase NA 6U Rackmount Uninterruptible Power System AF429A

HP R12000/3 12000VA Three Phase INTL 6U Rackmount Uninterruptible Power System AF430A

NOTE: Please see the QuickSpecs for additional information:

http://h18004.www1.hp.com/products/quickspecs/12857_div/12857_div.html
(Worldwide)

NOTE: For additional information on sizing your server, please reference:

<http://www.upssizer.com>

HP Rack Series

HP Rack 10000 G2 Series (Graphite Metallic)

HP 10642 G2 Shock Universal Rack AF002A

HP 10642 G2 1200mm deep Shock Rack AF092A

HP 10647 G2 1200mm deep Shock Rack AF094A

NOTE: HP BladeSystem c7000 Enclosure is not supported in a 14U rack

NOTE: Please see the QuickSpecs for Technical Specifications and additional information:

http://h18000.www1.hp.com/products/quickspecs/12402_div/12402_div.html
(Worldwide)

NOTE: For additional information regarding Rack Cabinets, please see the following URL: <http://www.hp.com/go/rackandpower>

Related Options

HP Rack Options

Keyboards and Monitors

HP USB BFR with PVC Free US Keyboard/Mouse Kit	631341-B21
HP USB BFR with PVC Free UK Keyboard/Mouse Kit	631344-B21
HP USB BFR with PVC Free FR Keyboard/Mouse Kit	631346-B21
HP USB BFR with PVC Free ES Keyboard/Mouse Kit	631348-B21
HP USB BFR with PVC Free DE Keyboard/Mouse Kit	631358-B21
HP USB BFR with PVC Free JP Keyboard/Mouse Kit	631360-B21
HP USB BFR with PVC Free IT Keyboard/Mouse Kit	631362-B21
HP USB BFR with PVC Free CN Keyboard/Mouse Kit	631364-B21
HP USB BFR with PVC Free AE Keyboard/Mouse Kit	638212-B21
HP USB BFR with PVC Free RU Keyboard/Mouse Kit	638214-B21

NOTE: Please see the [QuickSpecs for Technical Specifications and additional information:](#)

http://h18000.www1.hp.com/products/quickspecs/13972_div/13972_div.html
(Worldwide)

HP TFT7600 G2 KVM Console Rackmount Keyboard US Monitor	AZ870A
HP TFT7600 G2 KVM Console Rackmount Keyboard UK Monitor	AZ871A
HP TFT7600 G2 KVM Console Rackmount Keyboard DE Monitor	AZ872A
HP TFT7600 G2 KVM Console Rackmount Keyboard FR Monitor	AZ873A
HP TFT7600 G2 KVM Console Rackmount Keyboard IT Monitor	AZ874A
HP TFT7600 G2 KVM Console Rackmount Keyboard ES Monitor	AZ875A
HP TFT7600 G2 KVM Console Rackmount Keyboard DK Monitor	AZ876A
HP TFT7600 G2 KVM Console Rackmount Keyboard NO Monitor	AZ877A
HP TFT7600 G2 KVM Console Rackmount Keyboard SE/FI Monitor	AZ878A
HP TFT7600 G2 KVM Console Rackmount Keyboard CH Monitor	AZ879A
HP TFT7600 G2 KVM Console Rackmount Keyboard PT Monitor	AZ880A
HP TFT7600 G2 KVM Console Rackmount Keyboard BE Monitor	AZ881A
HP TFT7600 G2 KVM Console Rackmount Keyboard JP Monitor	AZ882A
HP TFT7600 G2 KVM Console Rackmount Keyboard RU Monitor	AZ883A
HP TFT7600 G2 KVM Console Rackmount Keyboard Intl Monitor	AZ884A
HP TFT7600 G2 KVM Console Rackmount Keyboard US TAA Monitor	AZ885A

NOTE: Please see the [QuickSpecs for Technical Specifications and additional information:](#)

http://h18000.www1.hp.com/products/quickspecs/13731_div/13731_div.html
(Worldwide)

NOTE: For additional information regarding Rack Options, please see the following URL: <http://www.hp.com/go/rackandpower>

Related Options

HP KVM Switches

HP Server Console 0x2x8 Port Analog Switch AF616A

HP Server Console 0x2x16 Port Analog Switch AF617A

NOTE: Please see the QuickSpecs for Technical Specifications and additional information:

http://h18000.www1.hp.com/products/quickspecs/11834_div/11834_div.html
(Worldwide)

NOTE: Cat5e cables are required to connect Interface Adapters to Consoles Switches. Cat52 cables can be found at the following URL:

<http://www.hp.com/go/kvm>

NOTE: For additional information regarding KVM switches, Serial Console servers, rack mount monitors, keyboards and all related options please see the following URL: <http://www.hp.com/go/kvm>

Rack Options

HP Universal 10642 G2 Front Door AF009A

HP Universal 10636 G2 Front Door AF019A

HP 10642 G2 Side Panel AF054A

HP 10636 G2 Side Panel AF056A

HP 36U Rack Rear Extension Kit AF060A

HP 10K G2 600W Graphite Stabilizer Kit AF062A

HP 10K G2 600W Heavy Duty Graphite Stabilizer Kit AF064A

HP 10000 G2 Series Rack Grounding Kit AF074A

HP 600W 10K G2 Rack Tie Down Kit AF076A

NOTE: For additional information regarding Rack Options, please see the following URL: www.racksolutions.com/hp.

HP Airflow Optimization

HP 10000 Series Rack Airflow Optimization Kit AF090A

NOTE: The Airflow Optimization kit is designed to prevent hot and cold air from mixing thus optimizing the temperature at which the chilled air enters the racked servers.

NOTE: When configuring racks through Factory Express, a Rack Optimization kit will automatically ship with the rack. This kit is recommended for all other rack configurations also.

Related Options

HP Tape Backup

The following options are supported in an Enterprise Backup Solution (EBS) environment with the HP BladeSystem c-Class enclosure. Please visit: <http://www.hp.com/go/ebs> for complete compatibility details.

HP MSL2024 Tape Library

HP MSL2024 1 LTO-4 Ultrium 1840 Tape Library	AJ033A
HP MSL2024 1 LTO-4 Ultrium 1840 Fibre Channel Tape Library	AJ034A
HP MSL2024 1 Ultrium 920 Drive Tape Library	AH169A

HP MSL4048 Tape Library

HP MSL4048 2 LTO-4 Ultrium 1840 Tape Library	AJ037A
HP MSL4048 1 LTO-4 Ultrium 1840 Fibre Channel Tape Library	AJ036A
HP MSL4048 2 LTO-4 Ultrium 1840 Fibre Channel Tape Library	AJ038A
HP MSL4048 1 Ultrium 920 Drive Tape Library	AH171A

NOTE: Please see the QuickSpecs for Technical Specifications and additional information or to create a complete solution; reference current compatibility information at: <http://www.hp.com/go/ebs>.

HP Care Pack Services **NOTE:** HP Care Pack services for the c7000 Enclosure cover the enclosure, power supplies and fans. HP qualified rack options are covered by these services when installed within the same rack. HP supported c-Class enclosure devices including pass thru, Ethernet interconnect and virtual connect modules are also covered by the c7000 enclosure Care Pack services.

NOTE: SAN/Fabric switches for the HP c-Class BladeSystem are not covered under the c7000 enclosure Care Packs, SAN/Fabric switches carry separate Care Packs. SAN/Fabric Switch Care Pack service level support should always be uplifted to match existing storage or server service level.

Hardware Services On-site Service

HP 3 year Next business day c7000 Enclosure Hardware Support	UE477E
--	--------

NOTE: Uplifts the Ethernet devices to the same level of service as the c-class enclosure

HP 3 year 4 hour 13x5 c7000 Enclosure Hardware Support	UE478E
HP 3 year 4 hour 24x7 c7000 Enclosure Hardware Support	UE479E
HP 3 year 6 hour 24x7 Call to Repair c7000 Enclosure Hardware Support	UE480E

Support Plus 24

HP 3 year Support Plus 24 Insight Control for Linux BladeSystem c7000 Service	UK137E
HP 3 year Support Plus 24 Insight Control BladeSystem c7000 Service	UH322E

Installation & Start-up Services

HP Startup Blade System c-Class Infrastructure Service	UE602E
HP Startup Blade System c-Class Enhanced Network Service	UE603E
HP Install c-Class Enclosure & ServerBlade Service	UE494E
HP Install c-Class Server Blade Service	UE493E

NOTE: For more information, customer/resellers can contact:

<http://www.hp.com/services/bladessystemservices>

NOTE: The HP Care Pack service part numbers below covers the HP Brocade 4Gb, 12 Port SAN Switch and Brocade 4/24/ SAN Switch.

Hardware Services On-site Service

HP 3 Years Next business day c-Class SAN Switch Hardware Support	UE436E
HP 3 Years 4 hour 13x5 c-Class SAN Switch Hardware Support	UE437E
HP 3 Years 4 Hour 24 hours days 1-7 c-Class SAN Switch Hardware Support	UE438E
HP 3 Years 6 Hour 24x7 Call-To-Repair c-Class SAN Switch Hardware Support	UE439E

Related Options

HP Installation Storage Switches Service	U5988E
NOTE: The HP Care Pack service part numbers below covers the Brocade 4/24 SAN Switch Power Pack.	
Hardware Services On-site Service	
Support Plus	
HP 3 year Support Plus 4/24 SAN Switch Power Pack Service	UE728E
Support Plus 24	
HP 3 year Support Plus 24 4/24 Switch Power Pack Service	UE729E
NOTE: The HP Care Pack service part numbers below covers the HP Cisco MDS 9124e 12 port and 24 port Fabric Switch.	
Hardware Services On-site Service	
HP 3 year Next business day MDS 9124e Switch Hardware Support	UF313E
HP 3 year 4 hour 13x5 MDS 9124e Switch Hardware Support	UF972E
HP 3 year 4 hour 24x7 MDS 9124e Switch Hardware Support	UF973E
HP 3 year 6 hour 24x7 MDS 9124e Switch Hardware Support	UF974E
HP Installation Storage Switches Service	U5988E
Software Installation and StartUp Services	
HP Installation and Startup for Insight Control Server Deployment - previously Rapid Deployment Pack	U5683E
NOTE: Provides installation on a Customer supplied server designated as a Deployment Server. Includes the deployment of a single server. This new server will be deployed using either one of the pre-configured scripts or an image. In addition, the service will provide for the capture and storage of the configuration of the newly deployed server and orientation on product usage. To be delivered during standard office ours, standard office days.	
HP Startup HP Systems Insight Manager Service	UA041E
HP Installation and Startup for Insight Control for Linux	UF372E
Software Operating Environment Care Packs	
HP 1 year 24x7 10 incidents Microsoft/Novell Software Technical Support	U9269E
HP 1 year 24x7 10 incidents SuSE IA32 Software Technical Support	U9936E
NOTE: For more information, customer/resellers can contact: www.hp.com/services/servers	
BCS Flexible Care Packs Integrity blade server enclosure	
NOTE: HP Care Pack services for the c7000 Enclosure cover the enclosure, power supplies and fans. HP qualified rack options are covered by these services when installed within the same rack. HP supported c-Class enclosure devices including pass thru, Ethernet interconnect and virtual connect modules are also covered by the c7000 enclosure Care Pack services.	
NOTE: SAN/Fabric switches for the HP c-Class BladeSystem are not covered under the c7000 enclosure Care Packs, SAN/Fabric switches carry separate Care Packs. SAN/Fabric Switch Care Pack service level support should always be uplifted to match existing storage or server service level.	
Hardware Services On-site Service	
Next Business Day On-site Service, 5-Day x 9-Hour Coverage, 3 Years, Electronic	HA101A3#6Q6
NOTE: Uplifts the Ethernet devices to the same level of service as the c-class enclosure.	
4-Hour On-site Service, 5-Day x 13-Hour Coverage, 3 Years, Electronic	HA103A3#6Q6
4-Hour On-site Service, 7-Day x 24-Hour Coverage, 3 Years, Electronic	HA104A3#6Q6

Related Options

6-Hour Call to Repair, On-site Service, 7-Day x 24-Hour Coverage, 3 Years, Electronic	HA105A3#6Q6
Support Plus	
Support Plus Service, 5-Day x 13-Hour Coverage	HA109A3#6Q6
Support Plus 24	
Support Plus 24 Service	HA110A3#6Q6
Proactive 24 Service - Mission Critical proactive environment 24x7 4hr onsite HW support	HA111A3#6Q6
Critical Service - Mission Critical proactive environment 6-Hour Call-to-Repair onsite HW support	HA112A3#6Q6
Installation & Start-up Services	
HP BladeSystem c7000 Infrastructure Installation and Startup Service for Blade Hardware and Insight Control Software, Electronic	HA114A1#57A
NOTE: The HP Care Pack service part numbers below covers the HP Brocade 4Gb, 12 Port SAN Switch and Brocade 4/24 SAN Switch.	
Hardware Services On-site Service	
Next Business Day On-site Service, 5-Day x 9-Hour Coverage, 3 Years, Electronic	HA101A3#85J
4-Hour On-site Service, 5-Day x 13-Hour Coverage, 3 Years, Electronic	HA103A3#85J
4-Hour On-site Service, 7-Day x 24-Hour Coverage, 3 Years, Electronic	HA104A3#85J
6-Hour Call to Repair, On-site Service, 7-Day x 24-Hour Coverage, 3 Years, Electronic	HA105A3#85J
Hardware Installation, Electronic	HA113A1#5D2
NOTE: The HP Care Pack service part numbers below covers the Brocade 4/24 SAN Switch Power Pack.	
Hardware Services On-site Service	
Support Plus	
Onsite HW support, 8am-9pm, M-F, 4hr response and SW Tech support offsite, onsite at HP's discretion, 8am-9pm, M-F 2hr response time excluding HP holidays, Electronic	HA109A3#85K
Support Plus 24	
Onsite HW support 24x7, 4hr response and SW Tech support offsite, onsite at HP's discretion, 24x7 2hr response time including HP holidays, Electronic	HA110A3#85K
NOTE: The HP Care Pack service part numbers below covers the HP Cisco MDS 9124e 12 port and 24 port Fabric Switch.	
Hardware Services On-site Service	
Next Business Day On-site Service, 5-Day x 9-Hour Coverage, 3 Years, Electronic	HA101A3#87L
NOTE: Uplifts the Ethernet devices to the same level of service as the c-class enclosure.	
4-Hour On-site Service, 5-Day x 13-Hour Coverage, 3 Years, Electronic	HA103A3#87L
4-Hour On-site Service, 7-Day x 24-Hour Coverage, 3 Years, Electronic	HA104A3#87L
6-Hour Call to Repair, On-site Service, 7-Day x 24-Hour Coverage, 3 Years, Electronic	HA105A3#87L
Hardware Installation, Electronic	HA113A1#5D2
NOTE: For more information, customer/resellers can contact: www.hp.com/services/servers	

Storage

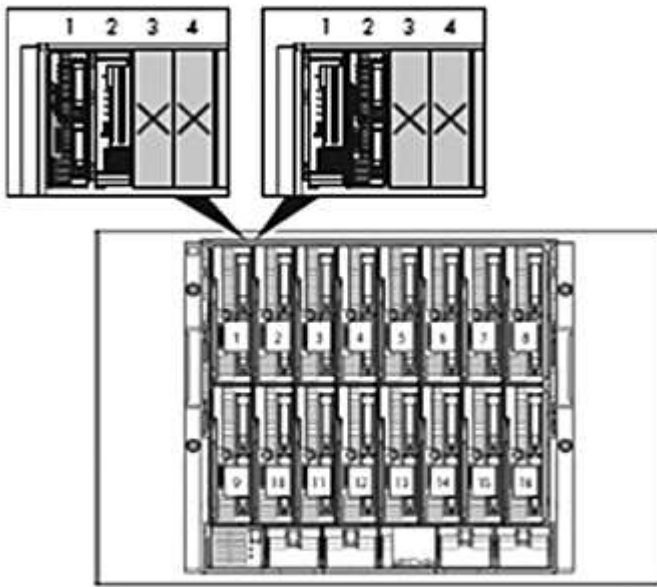

Figure 1 Installing a tape blade adjacent to a half-height server blade.

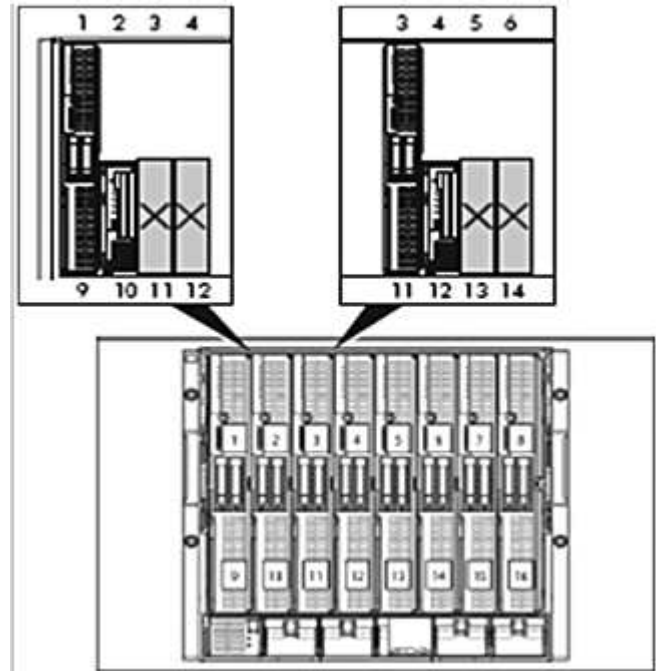

Figure 2 Installing a tape blade adjacent to a full-height server blade.

Installing Tape or Storage Blade

Description	Quantity Supported	Position Supported	Comments
Connecting a tape or storage blade to an adjacent half-height server blade (Figure 1)	Up to 8 per HP BladeSystem c-Class c7000 Enclosure	Odd or Even slots next to partner server blade	<ul style="list-style-type: none"> A tape or storage blade supports one partner server blade, and one partner server blade supports one tape or storage blade. Identify the partner server blade to be installed with the tape or storage blade. The two blades always occupy a pair of slots, as follows: 1 & 2, 3 & 4, 5 & 6, 7 & 8, 9 & 10, 11 & 12, 13 & 14, 15 & 16. If the partner server blade is installed in an odd-numbered bay, the tape or storage blade is installed in the adjacent even-numbered bay to the right. If the partner server blade is installed in an even-numbered bay, the tape or storage blade is installed in the adjacent odd-numbered bay to the left.
Connecting a tape or storage blade to an adjacent full-height server blade (Figure 2)	Up to 4 per HP BladeSystem c-Class c7000 Enclosure	Slots 10, 12, 14, or 16 (lower bays only)	<ul style="list-style-type: none"> A tape or storage blade supports one partner server blade, and one partner server blade supports one tape or storage blade. When partnering a tape or storage blade with a full height server blade, an HP PCI Express Mezzanine Pass-Thru Card for BladeSystem c-Class (431643-B21) is required. This card is installed in mezzanine 3 connector in the server blade. Identify the partner server blade to be installed with the tape or storage blade. The two blades always occupy a pair of slots, as follows: 9 & 10, 11 & 12, 13 & 14, 15 & 16. The partner server blade is installed in an odd-numbered bay. The tape or storage blade is installed in the adjacent even-numbered bay to the right.

Storage

- The tape or storage blade is always located on the lower row of the enclosure in an even-numbered bay (slots 10, 12, 14 or 16)

Power Specifications

HP BLc7000 Enclosure 2400 Watts Platinum Efficiency Power Supply					
Part Number	588603-B21				
Input Voltage Range (Vrms)	200-240				
Frequency Range (Nominal) (Hz)	50 / 60				
Nominal Input Voltage (Vrms)	200	208	220	230	240
Maximum Rated Output Wattage	2450	2450	2450	2450	2450
Nominal Input Current (A rms)	13.9	13.4	12.6	12.0	11.4
Maximum Rated Input Wattage Rating (Watts)	2692	2692	2678	2678	2663
Maximum Rated VA (Volt-Amp)	2778	2778	2762	2762	2747
Efficiency (%) at Max. Rated Output Wattage	91	91	91.5	91.5	92
Power Factor	0.98	0.98	0.98	0.98	0.98
Leakage Current (mA)	0.97	1.01	1.06	1.11	1.16
Maximum Inrush Current (A peak)	100	100	100	100	100
Maximum Inrush Current duration (mS)	10	10	10	10	10
Maximum British Thermal Unit Rating (BTU-Hr)	9186	9186	9136	9136	9086

NOTE:
 To review maximum system power ratings for facilities planning purposes use the Active Answers Power Calculator which is available via the online tool located at URL: <http://www.hp.com/go/bladeSystem/powercalculator>

Technical Specifications

Server Blade and Fan Population Guidelines

Fan bay numbering

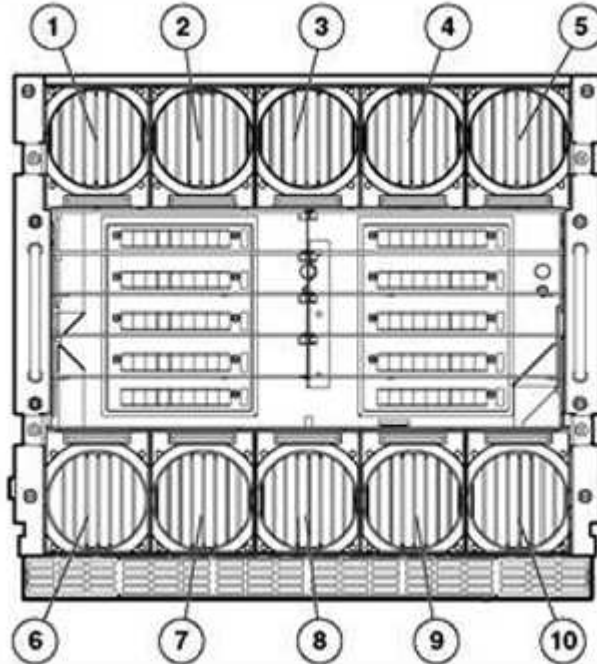

Fans must be placed in the following bays

Number of Fans	Fan Bays Used
4	4, 5, 9, 10
6	3, 4, 5, 8, 9, 10
8	1, 2, 4, 5, 6, 7, 9, 10
10	1, 2, 3, 4, 5, 6, 7, 8, 9, 10

NOTE: For correct operation fans and server blades must be installed in the correct bays. The BladeSystem Onboard Administrator will ensure that fans and blades are correctly placed before allowing systems to power on.

Half-height server blade bay numbering

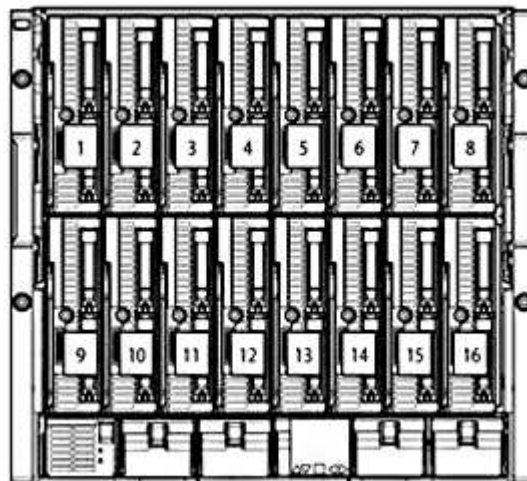

- 1. Device Bay 1
- 2. Device Bay 2

- 9. Device Bay 9
- 10. Device Bay 10

Technical Specifications

- | | |
|-----------------|-------------------|
| 3. Device Bay 3 | 11. Device Bay 11 |
| 4. Device Bay 4 | 12. Device Bay 12 |
| 5. Device Bay 5 | 13. Device Bay 13 |
| 6. Device Bay 6 | 14. Device Bay 14 |
| 7. Device Bay 7 | 15. Device Bay 15 |
| 8. Device Bay 8 | 16. Device Bay 16 |

NOTE: Half-height servers should be populated from top and bottom from left to right from the front of the enclosure. So the first two half-height servers would be placed in bays 1 & 9 the second two half-height servers would be placed in bays 2 & 10 and so on until the enclosure is full.

Full-height server blade bay numbering

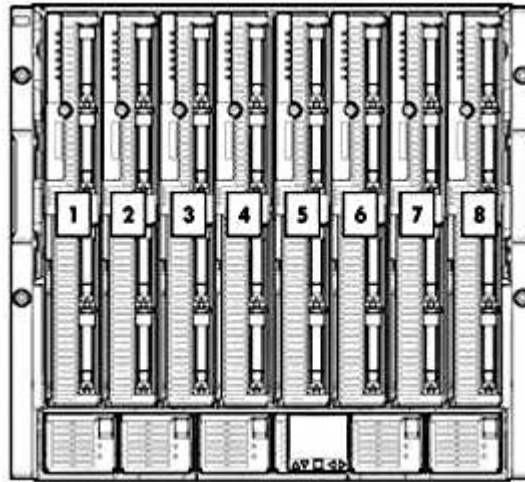

- | | |
|-----------------|-----------------|
| 1. Device Bay 1 | 5. Device Bay 5 |
| 2. Device Bay 2 | 6. Device Bay 6 |
| 3. Device Bay 3 | 7. Device Bay 7 |
| 4. Device Bay 4 | 8. Device Bay 8 |

NOTE: Full-height servers should be populated from left to right.

Mixed Configuration - Full Height and Half-Height Population rules

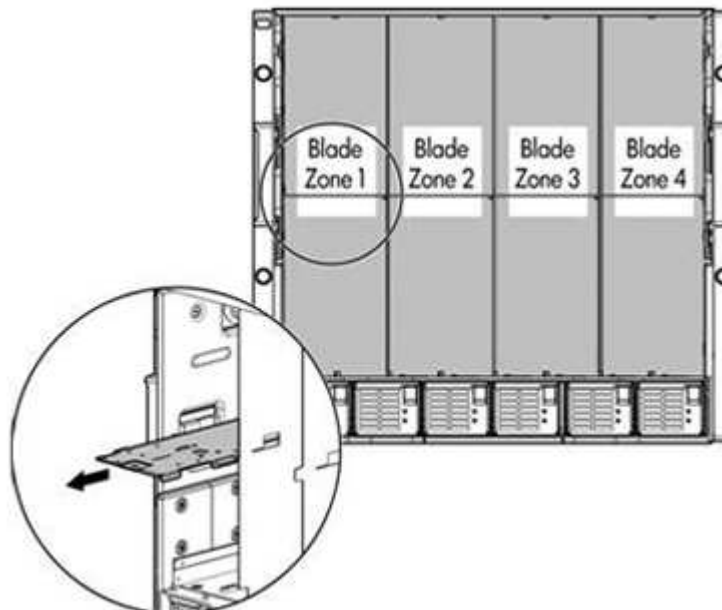

Technical Specifications

The c7000 enclosure is divided into 4 quadrants by the vertical support metalwork. Within each quadrant a removable divider is used to support half height devices. To install a full-height blade in any quadrant this divider must be removed. As a consequence a quadrant can only contain either full-height server blades or half-height server blades.

NOTE: Storage blades and Tape blades can be installed in the same quadrant as both full-height and half-height blades, a bracket ships with each SB40c/Tape Blade that allows a half-height blade to be mounted on top of the storage blade.

NOTE: The lower tape or storage blade cannot be removed without first removing the upper half height blade.

HP BladeSystem c7000 Server Blade Enclosure	Dimensions	Height	17.4 in (442 mm)
		Width	17.6 in (447.04 mm)
		Depth	32 in (813 mm)
	Shipping Dimensions	Height	29.88 in (759 mm)
		Width	23.88 in (607 mm)
		Depth	39.88 in (1013 mm)
	Single Phase Enclosure Weight	Unboxed	192 lb (87 kg)
		Shipping	235 lb (106.6 kg)
	Three -Phase Enclosure NA/JPN Weight	Unboxed	222 lb (100.7 kg)
		Shipping	265 lb (120.2 kg)
	Three-Phase Enclosure International Weight	Unboxed	222 lb (100.7 kg)
		Shipping	265 lb (120.2 kg)
	DC Input Enclosure Weight	Unboxed	151 lb (68.5 kg)
		Shipping	194 lb (88 kg)
	Max Enclosure Weight (approximate)	Unboxed	450 lb (204 kg)
		Shipping	493 lb (223.6 kg)
	Temperature Range	Operating	50° to 95° F (10° to 35° C)
		Non-Operating	-22° to 140° F (-30° to 60° C)
	Relative Humidity	Operating	10 to 90% relative humidity (Rh), 28°C (82.4°F) maximum wet bulb temperature, non-condensing.
		Non-Operating	5 to 95% relative humidity (Rh), 38.7°C (101.7°F) maximum wet bulb temperature, non-condensing.

NOTE: Operating temperature has an altitude derating of 1.8° F (1° C) per 1,000 ft (304.8 m). No direct sunlight. Upper operating limit is 10,000 ft (3,048 m) or 70Kpa/10.1 psia. Upper non-operating limit is 30,000 ft (9,144 m) or 30.3 KPa/4.4 psia. Storage maximum humidity of 95% is based on a maximum temperature of 113° F (45° C). Altitude maximum for storage is 70 KPa.

Power	Input Requirements - Single Phase Model	Rated input frequency	50 to 60 Hz	
		2400W PSU	Rated input voltage	200 to 240 VAC
			Rated input current	13.9 A at 200 VAC
			per power supply	13.3 A at 208 VAC 12.6 A at 220 VAC
			Rated input power	2780 VA
		per power supply		
	Input Requirements - Three Phase NA/JPN Model	Rated input voltage	200 to 208 VAC Line to Line 3-Phase Delta	
		Rated input frequency	50 to 60 Hz	

Technical Specifications

	2250W PSU	Max input current per line cord	22.6A at 200 VAC 21.8A at 208 VAC
		Max input power per line cord	7836VA Max
	2400W PSU	Max input current per line cord	24A at 200 VAC 23.1A at 208 VAC
		Max input power per line cord	8340 VA Max
Input Requirements - Three Phase International Model	Rated input voltage	346 VAC to 415 VAC Line to Line 200 VAC to 240 VAC Line to Neutral 3-Phase WYE	
	Rated input frequency	50 to 60 Hz	
	2250W PSU	Max input current per line cord	11.9 A at 220 VAC 10.9 A at 240VAC
		Max input power per line cord	7836 VA Max
	2400W PSU	Max input current per line cord	12.6 A at 220 VAC 11.5 A at 240VAC
		Max input power per line cord	8340 VA Max
Input Requirements DC Power	Rated Input Voltage	36 to -72 VDC	
	Max Input Current per line cord	75A	
	Max Input Power per line Cord	2700W	
Power Cords	Single Phase	IEC-320 C19-C20 1.22m (6 ft)	
	3-Phase NA/JPN	2 x NEMA L15-30p 3.048m (10 ft)	
	3-Phase International	2 x IEC-309 200/346 V - 240/415 V, 5-Pin, 6h 16A 3.048m (10 ft)	
	-48V DC Power	Terminal lug: 45DG 4AWG 1/4 2H Two-hole lug 45 degree bend 0.25in. (6.4mm) stud hole size 0.63in. (16mm) hole spacing	
Output Specifications (per power supply)	HP 2400W High Efficiency Hot-Plug Power Supply	200 - 240 VAC 2400 W 92% Efficiency	
	HP 2250W -48V DC Hot-Plug Power Supply	2250W	
Acoustic Noise	Listed are the declared A-Weighted sound power levels (LWAd) and declared average bystander position A-Weighted sound pressure levels (LpAm) when the product is operating in a 23°C ambient environment. Noise emissions were measured in accordance with ISO 7779 (ECMA 74) and declared in accordance with ISO 9296 (ECMA 109).		
	Idle		
	LWAd	7.1 Bels	
	LpAm	54 dBA	
	Operating		
LWAd	7.2 Bels		

Technical Specifications

		LpAm	54 dBA
Option Kits	Power Supply Option Shipping Dimensions	Height	8.75 in (223 mm)
		Width	8.63 in (219 mm)
		Depth	35.13 in (892 mm)
		Weight	8.5 lbs (3.85 kg)
	Fan Option Shipping Dimensions	Height	8.75 in (223 mm)
		Width	9.75 in (248 mm)
		Depth	15.88 in (403 mm)
		Weight	4.0 lbs (1.8 kg)
	BladeSystem Onboard Administrator Option Shipping Dimensions	Height	2.50 in (63.5 mm)
		Width	9.88 in (251 mm)
		Depth	13.50 in (343 mm)
		Weight	4.0 lbs (1.8 kg)

Environmental-friendly Products and Approach **End-of-life Management and Recycling**

Hewlett-Packard offers end-of-life HP product return, trade-in, and recycling programs in many geographic areas. For trade-in information, please go to <http://www.hp.com/go/green>. To recycle your product, please go to: <http://www.hp.com/go/green> or contact your nearest HP sales office. Products returned to HP will be recycled, recovered or disposed of in a responsible manner.

The EU WEEE directive (2002/95/EC) requires manufacturers to provide treatment information for each product type for use by treatment facilities. This information (product disassembly instructions) is posted on the Hewlett Packard web site at: <http://www.hp.com/go/green>. These instructions may be used by recyclers and other WEEE treatment facilities as well as HP OEM customers who integrate and re-sell HP equipment.

© Copyright 2012 Hewlett-Packard Development Company, L.P.

The information contained herein is subject to change without notice.

Microsoft and Windows NT are US registered trademarks of Microsoft Corporation.

Intel, the Intel logo, Xeon and Xeon Inside are trademarks of Intel Corporation in the U.S. and other countries.

AMD Opteron™ is a US registered trademark of AMD Corporation.

The only warranties for HP products and services are set forth in the express warranty statements accompanying such products and services. Nothing herein should be construed as constituting an additional warranty. HP shall not be liable for technical or editorial errors or omissions contained herein.